

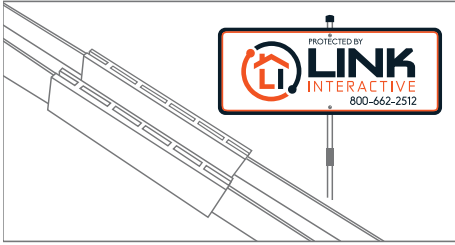

LINK[®]
INTERACTIVE

Security + Automation Made Easy

QUICK START GUIDE



To set up your yard sign, attach the sign to the post with the two provided screws. Then slide the top and bottom pieces of the post into the gray coupler. Lightly hammer the post into the ground at the desired location. Finally, place the black plastic cap on top of the post.

Place window decals at eye level on the inside of the windows near entrances.

WELCOME TO LINK INTERACTIVE



- 1** Keep all of the components in their original boxes until you get to the installation step!
- 2** Follow the installation instructions on pages 2-12 for your selected equipment.
- 3** Complete the steps on page 13 to activate your system.

Thank you for choosing Link Interactive! We hope you've had a great experience with us so far and we look forward to providing you with unparalleled customer service as you install and activate your new Link Interactive system.

Login Information

Go to www.linkinteractive.com. Click "Login" and then "New User Registration." Use the information provided below to gain access. This portal will show account billing and automatic payment settings, and allow you to view emergency contacts. From this customer portal, you can also manage your interactive services, such as geofencing, scene settings, smart thermostat schedules and more by clicking "Manage System" inside the portal.

App Download

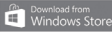
Search for the Alarm.com app  using   . Then use the information in the box below to log in to the app to remotely control your security and automation system.

Central Station Information: 1-800-662-2512

To see exactly what happens in an emergency please check out www.linkinteractive.com/monitoring-station-procedures/

THERE ARE 3 IMPORTANT CODES FOR YOU TO REMEMBER

Verbal Password: _____
Master Code: _____
Installer Code: _____
Alarm.com Login: _____
Password: _____
Central Station Account #: _____

Your **Verbal Password** is used to verify your identity when an alarm is triggered or when speaking with Link Interactive about your account.

Your **Master Code** is used to arm or disarm your control panel. (You can change this code later. You'll never be asked for this over the phone.)

Your **Installer Code** is used to access the Installer Toolbox in your control panel.

For assistance, please call our customer support at 1-877-826-5443.



CONTROL PANEL

Superior Security and Automation start here. The touch-screen Control Panel serves as the nerve center for your system. It's a powerful device, but setting it up is simple, so let's get started.

PLACE: Place your Touch-Screen Control Panel on a counter, tabletop or shelf in a central location in your home. Avoid placing within 4 feet of electronic devices or large metallic objects such as a refrigerator, TV or washing machine.

SETUP:

Step 1

Undo the locking screw from the back of the panel, remove the SmartMount backplate.

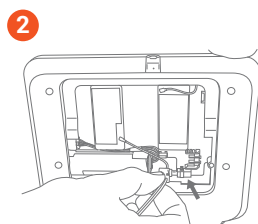
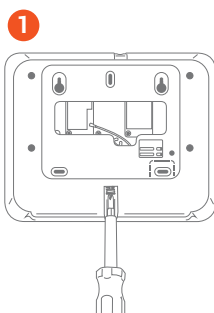

Step 2

With the included power supply and cable, plug the barrel connector into the barrel jack. Be sure the barrel connector is properly seated.

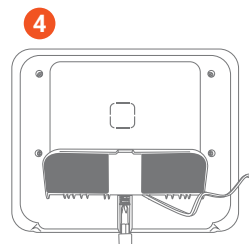

Step 3

Insert the hooks on the table stand into the back of the panel, then swing down and press into place.

Step 4

Screw in the locking screw from the bottom of the panel to secure it to the table stand.

ARMING YOUR SYSTEM:

Stay Mode - Activates all perimeter sensors and allows you to move around your home without triggering the alarm.

Away Mode - Activates all sensors and protects your home while you're away.



NEXT UP

Tips for easy setup

TIPS

Here are some important sensor setup guidelines to help your system perform best.

PLACEMENT DISTANCE

All sensors should be placed within 80 feet of the control panel.

WHERE NOT TO PLACE

Sensors are not weatherproof, and should be kept indoors. Avoid placing in high-humidity areas.

PREP THE SURFACE

Before mounting any sensors using the included adhesive, make sure the surface to which you are adhering the sensor is clean and dry. Dampen a paper towel or rag to wipe the surface, and then go over the area with a dry one.

PRESS AND HOLD

After removing the backing from the adhesive and placing a sensor on a surface, be sure to press it firmly in place and hold for 30 seconds.

ANCHORS

Use the included anchors to ensure the sensors don't fall off.

VIDEOS

We have installation videos that provide you with step-by-step instructions. Check out our resource center at www.linkinteractive.com/installation-guide/

Important Note: *Your system will only contain the components you ordered at the time of purchase.*

NEXT UP

***Now that you've learned some pro tips
you're ready to start placing your sensors.***



DOOR & WINDOW SENSOR



Magnet

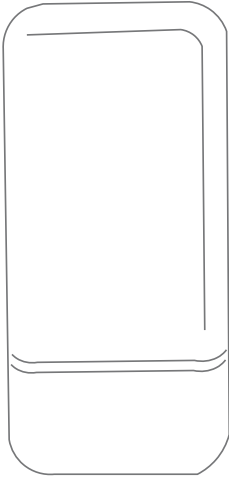

Transmitter

The Door and Window Sensor has two pieces: a magnet (smaller piece) and a transmitter (larger piece). Together, they detect the opening of just about anything—doors, windows, drawers, cabinets and more.

Regardless of where you are placing them, ensure that the magnet on the sensor is placed on the side of the transmitter that has the arrow, no more than a pen's width apart.

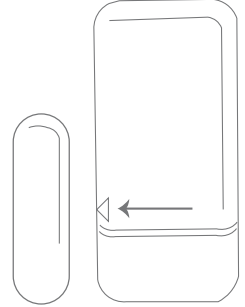

NEXT UP

Let's start by placing your first sensor.

DOOR SENSOR PLACEMENT

The doors on the ground floor of your home are the most common entry points, so it makes sense to start there.

Check the packing slip for the name you selected at the time of purchase that corresponds with the placement of each door sensor. Then remove the sensor from the box and go to the installation location.

STANDARD DOOR PLACEMENT

Before you place your sensor, take a look at your door. If the door and the frame are flush when the door is closed, you can place the magnet (smaller piece) on the door and the transmitter (larger piece) on the frame, aligned as shown in the preferred install.

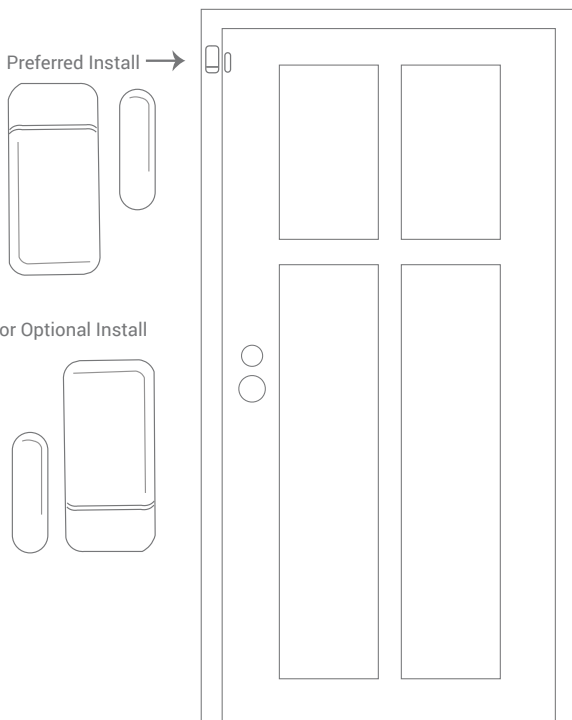

If you have crown molding or any other type of decorative molding, it might be more convenient for you to reverse the setup, with the transmitter on the door and the magnet on the frame, as shown in the optional install. If your door is different, visit the Resource Center at www.linkinteractive.com/installation-guide/ for setup instructions for alternative door types.

NEXT UP

Once you've gotten all of your ground floor doors covered, let's secure the windows.



WINDOW SENSOR PLACEMENT

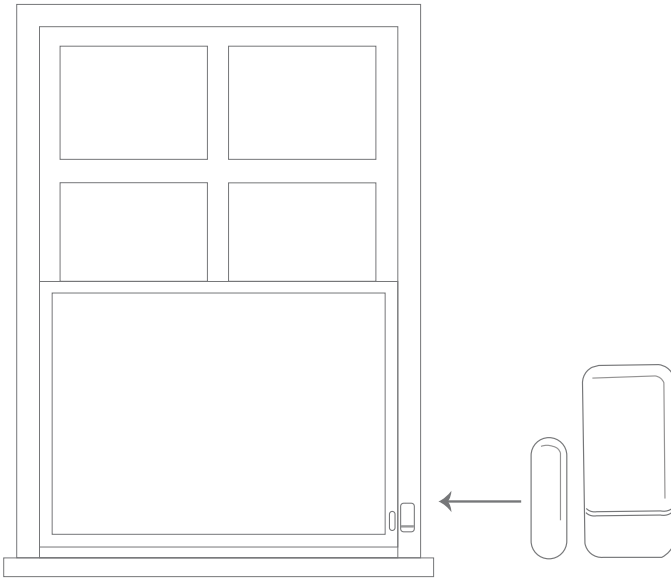

Placing sensors on your windows is quite similar to placing them on your doors. Again, it's important to ensure that you properly align the pieces and position them no more than a pen's width apart. Check the packing slip for the name you selected at the time of purchase that corresponds with the placement of each sensor. Then remove the sensor from the box and go to the installation location.

STANDARD WINDOW PLACEMENT

Before you place your sensor, examine your windows. If the window has sliding panes, reference the setup image above for proper placement. If your window is different, visit the Resource Center at www.linkinteractive.com/installation-guide/ for setup instructions for alternative window types.

NEXT UP

Now that you've got your doors and windows secured, let's move on to Motion Sensors.



MOTION SENSOR

The Motion Sensor detects movement across a room or hallway, and should be used to secure larger, high-traffic areas.

The motion sensor has a range of 90 degrees, and detects motion up to 30' away.

Determine where you want to mount your motion sensor. You can choose to wall mount the sensor or rest it on a shelf. Do not place the sensor near a ventilation source or pointed toward windows.

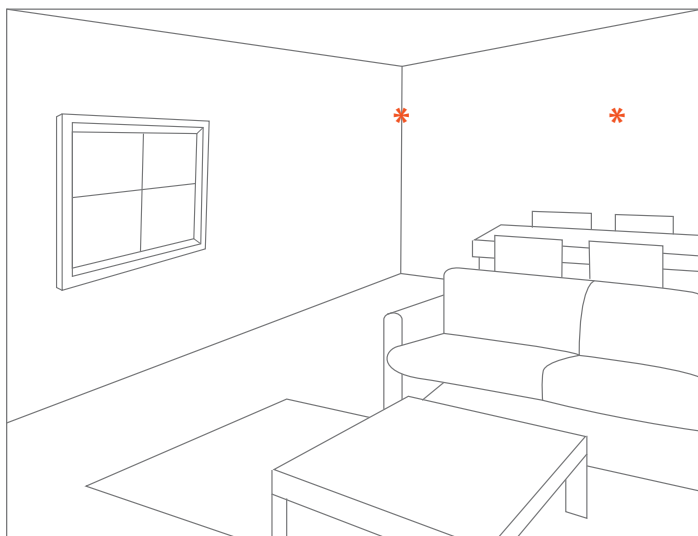
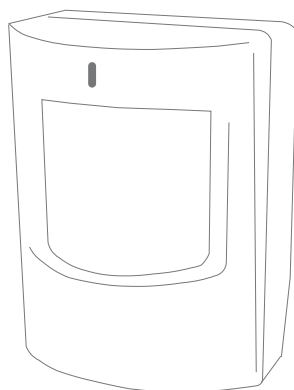

Note: In order to save battery power, the motion sensor rests for approximately 5 minutes after sending a signal before sending a signal again. While you are testing the sensor, please keep in mind this 5-minute resting period. For the sensor to reset it must sit idle for 5 minutes with no motion detection.

NEXT UP

Finish placing the Motion Sensor.



MOTION SENSOR PLACEMENT

MOTION SENSOR PLACEMENT

Step 1

Open device casing.

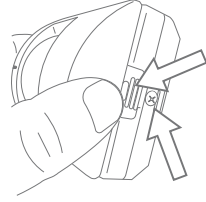

Step 2

Remove battery tabs.

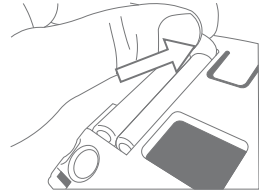

Step 3

Choose mounting type.

Step 4

Secure all hardware.

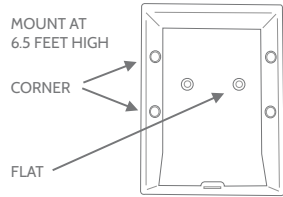

Step 5

Learn device into panel: Place your panel in "Auto Learn" mode.

Open and close the case to tamper the device.

Customize name and settings as desired and touch "ADD."

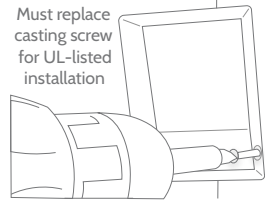

Note: If you have pets, visit the Resource Center at www.linkinteractive.com/faq for tips to set up your Motion Sensor for use with pets.

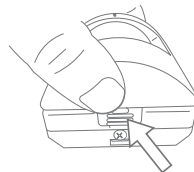

ADD

NEXT UP

**Got a Glass Break Sensor?
See where to place it.**



GLASS BREAK SENSOR

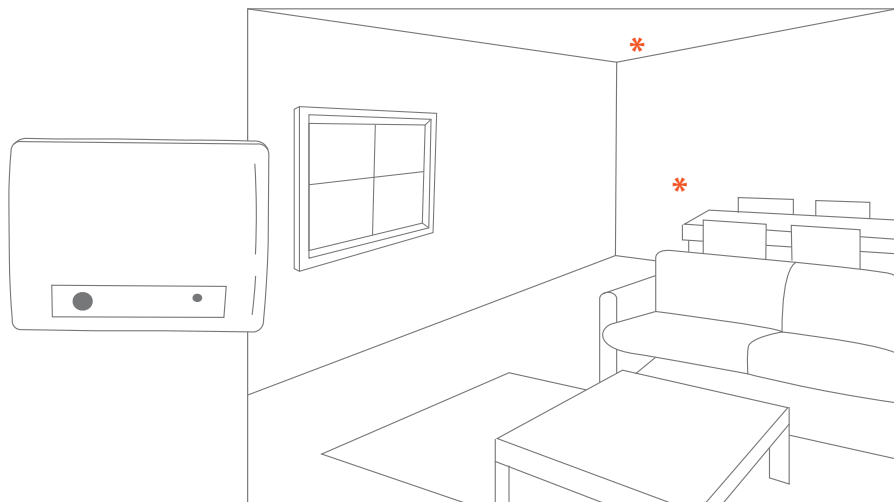

Use your Glass Break Sensor to secure any room with one or more windows.

PLACE: Place the Glass Break Sensor no more than 25 feet from the window or windows you wish to protect. You can mount it to a wall or ceiling or set it on a shelf.

STEP 1

Pull top and bottom of detector to remove cover from base.

STEP 2

Place back plate on wall opposite or adjacent to window. Affix back plate to desired location with supplied 3 long mounting screws and anchors.

Note: Also, keep in mind that heavy draperies will hamper the effectiveness of your Glass Break Sensor.

STEP 3

Push cover onto back plate until it snaps in place.

NEXT UP

Now that you have your home protected, let's move on to Life Safety Sensors. We will start with our SMOKE/HEAT Sensor.



SMOKE/HEAT SENSOR

The Smoke/Heat Sensor detects smoke or rapid changes in temperature in your home. Like all of our life safety and environmental sensors, your Smoke/Heat Sensor is always monitored, even when your system is disarmed.

PLACE: For maximum coverage, place your Smoke/Heat Sensor on the ceiling or wall of a common hallway shared by multiple bedrooms or a central room in the home.

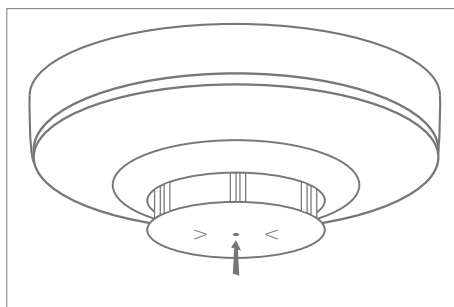
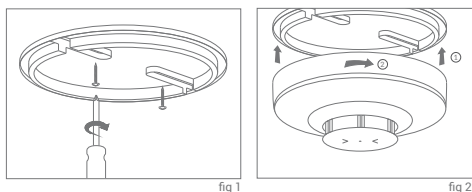

If placing on the ceiling, position sensor in a central spot 4 inches away from the wall. If placing on the wall, position 4 to 12 inches below the ceiling.

Do not place the sensor in any of the following areas: in a kitchen or garage, near a ventilation source such as an exhaust fan, near a shower or other potentially humid areas, near a furnace, space heater or hot water heater.

STEP 1

Remove the smoke detector from its base by twisting it counterclockwise. Use the two screws to secure the base to the ceiling or desired location (fig 1). Then fit the smoke detector inside the base (fig 2).

STEP 2

With the IQ Panel in SYSTEM TEST, press the detector's "Test Hush" button for approximately 10 seconds, continue to hold down the button until you hear 4 sets of short beeps (fig 3). Release the button after the beeps have sounded. Lastly, verify that the signal was received at the control panel.



NEXT UP

Get notified if there is a disaster in your home.

KEY RING REMOTE

The Key Ring Remote allows you to arm or disarm your system from anywhere within 80 feet of the panel.

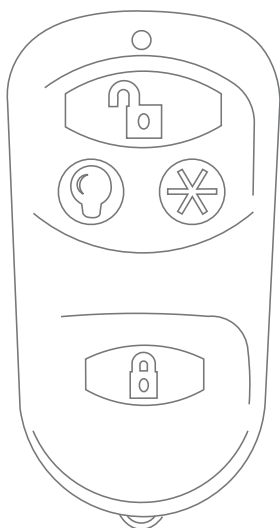

To arm "Stay" press the "Lock" button once.



To arm "Away (Doors, window, and motions) press the "Lock" button twice.



To disarm, press the "Unlock" button.

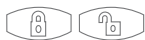

To send an emergency panic, press and hold "Lock" and "Unlock" together for 3 sec.

PLACE: Keep your Key Ring Remote close by you on a keychain, in a pocket or in a purse.



NEXT UP

Now it's time to activate your system!



CONGRATULATIONS!

YOU'VE COMPLETED THE SET-UP PROCESS.

ESSENTIAL STEPS TO COMPLETE AFTER INSTALLING YOUR SYSTEM

1. TEST YOUR SENSORS

Swipe down from the top > Press Settings > Advanced Settings > Enter User Code > System Tests > Sensor Test. Then tamper or trip each sensor to provide feedback at the panel.

2. TEST YOUR PANEL

Swipe down from the top > Press Settings > Advanced Settings > Enter User Code > System Tests > Panel Test > Run All.

3. CONDUCT A CELL TEST

Swipe down from the top > Press Settings > Advanced Settings > Enter User Code > System Tests > Cellular Test > Start.

4. CONNECT TO WI-FI

Swipe down from the top > Press Settings > Advanced Settings > Enter User Code > Wi-Fi > Choose your network and input your password.

5. CHECK FOR UPDATES

Swipe down from the top > Press Settings > Advanced Settings > Enter 2010 > Upgrade Using Network.

6. ACTIVATE YOUR SYSTEM

After installing your system, your 24/7 monitoring will not be activated until you call **1-877-826-5443** or email activations@linkinteractive.com.

Upon activation, you will also receive an emailed attachment which contains a Certificate of Monitoring that you can provide to your insurance company in order to receive any discounts offered.

Please note that if you do not install your system within 45 days from the ship date, we will automatically activate your system for you.

7. REGISTER YOUR ALARM SYSTEM WITH LOCAL AGENCIES

You may be required to register your new alarm system with your local police department, sheriff's office or emergency agencies depending on your installation address. It is your responsibility to contact your local authorities to determine registration, permit or licensing requirements. Failure to comply with the permitting requirements of your local authorities may result in a fine. Any fines or fees assessed to Link Interactive for failing to comply with the permitting requirements will be charged in full to your account.

Please call **1-877-826-5443** with any questions: M-F 8 a.m. to 10 p.m. and Saturday 9 a.m. to 6 p.m. - Central Time.

8. REFERRALS

Much of our business is grown through customer referrals to friends and family. If someone you know orders a system from us and lets us know you referred them, we'll say 'thank you' by crediting both accounts with one free month of monitoring!

CONTACT LINK FOR ALL PRODUCT RETURNS/WARRANTY QUESTIONS.
1-877-826-5443





www.linkinteractive.com • 1-877-826-5443